

Coffret métal extérieur

CTE800

- Acier électrozingué.
- Finition thermo-poudrage fine texture RAL 9010.
- Conception à façon sur cahier des charges.

LES COFFRETS EXTÉRIEURS

Références	Désignation
CTE800	Coffret fermé à clé. Fourni avec cinq rails din, un fond de coffret et cinq presses étoupes de Ø 16. Largeur utile : 5 x 33 modules.
CT800SF	Support feuillard pour coffret CTE600 (la paire)



CARACTÉRISTIQUES TECHNIQUES

Matière	Acier électrozingué
Finition	thermo-poudrage fine texture
Teinte	RAL 9010
Fermeture	par clés
Nombres de rail DIN	5
Modules utiles par rail DIN	33
Presses étoupes Ø 16	5
DIMENSIONS	
Hauteur	800
Largeur	600
Profondeur	180

Mise en oeuvre

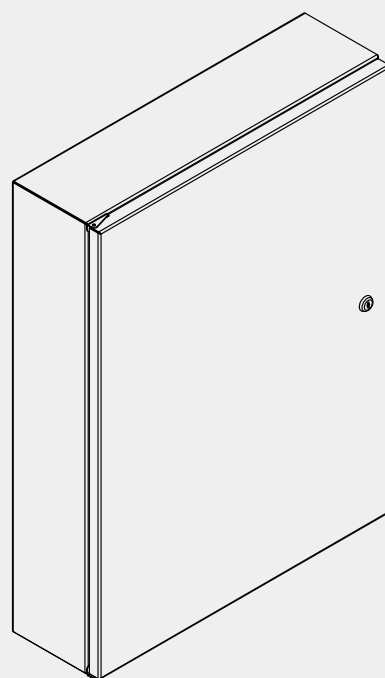
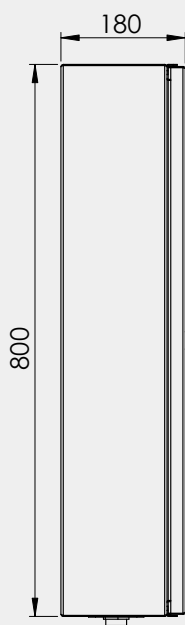
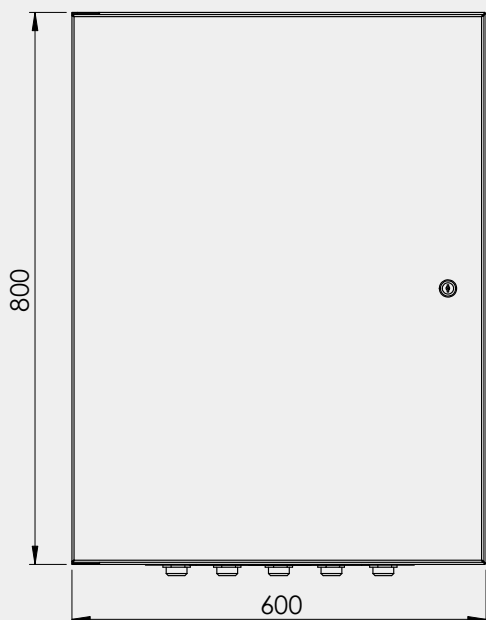
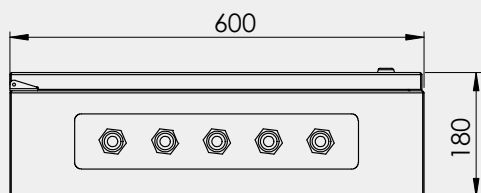

Nuancier

Nuancier RAL SOONE standard - Finitions lisse brillant ou fine texture.



RAL 1001
beige

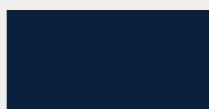

RAL 5011
bleu acier



RAL 7022
gris ombre

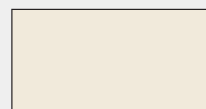

RAL 9001
blanc crème



RAL 1013
blanc perlé

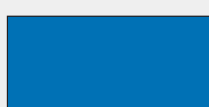

RAL 5015
bleu ciel

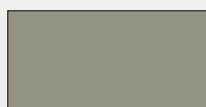

RAL 7030
gris pierre

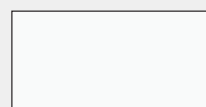

RAL 9003
blanc sécurité

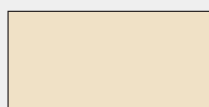

RAL 1015
ivoire clair



RAL 6005
vert mousse

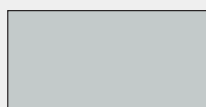

RAL 7035
gris pierre



RAL 9005
noir foncé

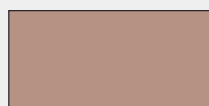

RAL 1019
gris beige

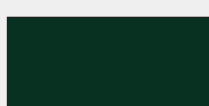

RAL 6009
vert sapin

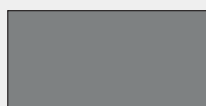

RAL 7037
gris poussière

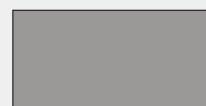

RAL 9006
aluminium gris



RAL 3000
rouge feu

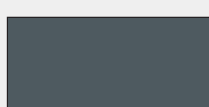

RAL 7011
gris fer

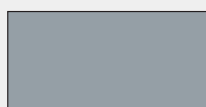

RAL 7040
gris fenêtre



RAL 9010
blanc pur



RAL 3005
rouge vin



RAL 7015
gris ardoise



RAL 8012
brun rouge



RAL 9016
signalisation



RAL 5003
bleu saphir

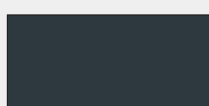

RAL 7016
gris anthracite



RAL 8014
brun sepia

Autres RAL disponibles
sur demande



NOTES

.....

.....

.....

.....

.....

.....

.....

.....

.....

.....

.....

.....

.....

.....

.....

.....

.....

.....



Fabricant
VIGIK

Fabrication
Française 

Contactez-nous

Une question ?

Une interrogation ?

Une demande de contact ?

Notre réactivité et volonté de répondre à toutes vos attentes participent à notre qualité de service.

Adresse

ZA de la Varenne
70190 Beaumotte Aubertans

Téléphone

Tél. : 03 84 68 39 00

Web

soone.io
contact@soone.io